



Reid Street  
Christchurch  
Dorset  
BH23 2BT  
Telephone. 01202 588 638  
Fax. 01202 588 639

[www.ekofires.co.uk](http://www.ekofires.co.uk)

3year  
guarantee

Electric fire collection V1

ELECTRIC FIRE COLLECTION



Our sympathetic philosophy and sustainable attitude means that we are committed to creating fires which have less environmental impact. Our new range of fires are kinder to the environment, more efficient and cost a lot less to run.

At ekofires we have a large range of electric fires to choose from. If you have a modern interior and looking for a Wall Mounted Electric Fire then you will not be disappointed. Our wall mounted electric fires come in an array of different materials and finishes; from Black granite to contemporary black glass. We also have a fantastic range of Inset Electric Fires which are designed to complement your new or existing fireplace. These are available in a choice of LED or LCD technology.

Alternatively, for the latest in home decoration we have a fashionable range of Electric Stoves from traditional black cast iron finish to modern graphite and white.

Finally, if you are after a one-box solution we have a range of LED Freestanding Electric Fire Suites that come complete with electric fire and fireplace combined.





## Relax and enjoy our fires in an aesthetic ambience designed to warm your heart and soul.

We are pleased to introduce a revolutionary collection of electric fires combining stylish design and innovative technology from ekofires. In this new and exciting range we have something to offer everyone, including iconic fire solutions that can be personalised to complement your decor or reflect your mood.

Our ekofires products are intended to inspire, giving shape to ideas and making desires real. We are pioneers in the pursuit to challenge our preconceived ideas of the traditional fireplace by creating ground breaking designs that evolve and adapt to our ever changing lifestyles and living spaces. Our electric range of products do not require a chimney or flue. This allows you to enjoy a fire not only in the living room but also the kitchen, study and dining room.

Our ekofires products are available throughout the UK from selected leading independent retailers who are fully trained and on hand to advise and help you choose the right ekofires product for your home.

We are delighted to bring to you this new and exciting range of fires and believe ekofires has all the right ingredients for you to decorate your home with style whether a modern or traditional focus.

Enjoy with ekofires.

Carl J. Richards  
Executive Chairman

# 04

## Inset electric fires

- 06. eko 1030
- 08. eko 1040
- 10. eko 1060/70
- 12. eko 1080/90

# 14

## Wall mounted electric fires

- 16. eko 1011
- 18. eko 1011 Grand
- 20. eko 1100 LCD
- 22. eko 1110
- 24. eko 1120
- 26. eko 1190

# 28

## Electric stoves & suites

- 30. eko 1150
- 32. eko 1250
- 34. eko 1350
- 36. eko 1200

# 38

## Tailoring & Technical

- 38. Tailoring specification - fires
- 40. Technical specification - fires
- 42. Tailoring specification - surrounds
- 43. Technical specification - surrounds

# 03

## Complete peace of mind

Relax and take it easy in front of one of our stunning fires while we look after you, knowing full well you have three years trouble free guarantee, dual safety features and that all of our products carry full CE approval.

Our extensive knowledge and vast experience in the development of electric fires has always ensured that we are at the cutting edge of technology. Efficiency, heat performance, running costs, reliability and of course your safety is of primary importance to us.

We were the first company in our industry to achieve the internationally recognised ISO 14001 Environmental Management System. The impact our business has on our planet is very important to us and we are continually improving our environmental performance in order to reduce this effect.

We are proud to be accredited with ISO 9001 Quality Management System, our commitment to meeting the stringent demands demonstrates our quality is second to none. Every fire is individually tested and fully calibrated in order to meet stringent quality control measures.

So confident are we of our fires that we include a 3 year guarantee on all our products to ensure trouble free pleasure. Subject to our terms and conditions listed at the back of this brochure.

That's it, simple - just complete peace of mind.



Q 06323





# 04

## Inset electric fires

If you are looking for a stylish electric fire to complement your fireplace then an inset electric fire could be right for you. It can instantly transform your house into a home not and provide an efficient focal point in a number of rooms. From elegant, traditional designs to the more modern look, eko fires has a wide variety of LED and LCD models for you to choose from.



### Technical specifications for installation

Electric fires require a fixed socket within 1.8 meters of the installed location. The socket must be easily accessible and NOT located directly above the appliance. It is recommended that any open flues be sealed off to prevent down draughts from causing nuisance cut off. These appliances must NOT be installed into bathrooms or within the immediate vicinity of showers or swimming pools. Do not allow appliances to become covered as this may cause overheating.

### What safety features are on the appliance?

For your added safety all our electric products are fitted with a thermal trip switch that monitors the temperature inside the appliance, and senses any change if it becomes covered or displaced for any reason. Can the flame effect be used independent of heat? All electric appliances benefit by having the flame effect operational on its own for visual.

### Benefits of inset electric fires

- No chimney or flue required
- Easy to use - simply take home and plug in
- Can be fitted full inset, semi inset or freestanding (spacer frames included)
- Can be installed on virtually any internal or external wall
- A wide range of traditional and modern fret and frames to choose from
- LED or LCD options available
- Remote control
- Timer control options (LED models only)
- Full thermostatic control (LED models only)



Model Shown  
eko 1030 shown with  
the Elysee fret.

Details:  
9 seasonal video scenes



# eko 1030

The eko 1030 is a premium LCD electric fire that sets a new standard in digital electric fire design. At the heart of this innovative fire is an interactive multimedia processor which delivers a range of stunning real-life film sequences with optical clarity and breathtaking realism through the LCD display.

The Eko 1030 features 9 seasonal video scenes: Log fire, twig fire, coal fire, 3 modern gas fires and a relaxing abstract, country river and fish tank scene. The log, twig and coal scenes feature crackling fire sounds while birds can be heard tweeting in the Country River scene. The Fish Tank scene is a must for summertime. A remote control is provided which operates the LCD effects and volume level only.

A discrete fan heater provides forward directional heat and is of good quality to reduce operating noise.

The frame of the fire is the Elysee fret. This is a modern cast design with horizontal curved bars. It has a slightly bowed profile with wider tapering feet detail which deliberately reduces the size of the ashpan making it a less prominent feature of this design.

The Elysee fret is available in: brass (solid brass), brass & black (solid brass), brushed chrome (brush chrome plated brass), chrome & black (lightweight aluminium), black (lightweight aluminium).

## Specifications

Fire Type	LCD Electric Fire
Control Type/Location	Manual - Switch & Remote Control. Remote control operates the LCD effects & volume only.
Heat Direction	Frontwards
Heat Input (Max/Min) Gross	2.0kW / 1.0kW
Heat Output (Max/Min) Gross	2.0kW / 1.0kW
Running Costs Per Hour (Max/Min)*	31.68p / 15.84p
Outline Dimensions**	W480 x H595 x D95mm
Installation	Inset
Air Vent Required	N/A
Safety	Thermal Trip Switch
Options	N/A

\*Price based on 15.84p/kWh. Electric prices may vary. Please check with your supplier. For energy efficiency please refer to online product fiche on [www.ekofires.co.uk](http://www.ekofires.co.uk)

\*\*Please refer to Technical specification for more information.

See page  
**39**  
For more  
fret & frame  
options

**3**year  
guarantee





Model Shown:  
eko 1040 shown with the  
Edwardian Timeless  
Surround: eko 7050 white

Details:  
9 seasonal video scenes

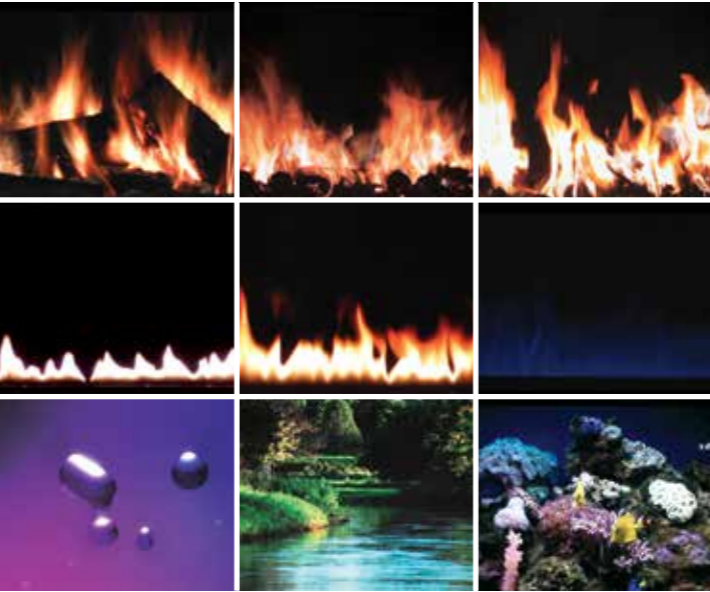

Specifications

Fire Type	LCD Electric Fire
Control Type/Location	Manual - Switch & Remote Control. Remote control operates the LCD effects & volume only.
Heat Direction	Frontwards
Heat Input (Max/Min) Gross	2.0kW / 1.0kW
Heat Output (Max/Min) Gross	2.0kW / 1.0kW
Running Costs Per Hour (Max/Min)*	31.68p / 15.84p
Outline Dimensions**	W480 x H595 x D95mm
Installation	Inset
Air Vent Required	N/A
Safety	Thermal Trip Switch
Options	N/A

\*Price based on 15.84p/kWh. Electric prices may vary. Please check with your supplier. For energy efficiency please refer to online product fiche on www.ekofires.co.uk

\*\*Please refer to Technical specification for more information.

# eko 1040

The eko 1040 is a premium LCD electric fire that sets a new standard in digital electric fire design. At the heart of this innovative fire is an interactive multimedia processor which delivers a range of stunning real-life film sequences with optical clarity and breathtaking realism through the LCD display.

The eko 1040 features 9 seasonal video scenes: Log fire, twig fire, coal fire, 3 modern gas fires and a relaxing abstract, country river and fish tank scene. The log, twig and coal scenes feature crackling fire sounds while birds can be heard tweeting in the Country River scene. The Fish Tank scene is a must for summertime. A remote control is provided which operates the LCD effects and volume level only.

A discrete fan heater provides forward directional heat and is of good quality to reduce operating noise.

The frame of the fire is The Edwardian Timeless. This is a premium solid cast design with integral fret. It is inspired by classic Edwardian period styling and adopts the same traditional iron foundry techniques in its manufacture. This product has been manufactured using traditional sand casting techniques.

See page  
**39**  
For more  
fret & frame  
options

**3**year  
guarantee





eko 1070 contemporary



**Model Shown:**  
eko 1060 shown with the brass Blenheim fret and three-piece bevelled brass frame.  
**Surround:** eko 7030 oak veneer

# eko 1060/70

Decorative heat at your finger tips. Modern technology creates this enchanting range of innovative electric fires with a traditional flame picture and attractive warm glow.

Combining a flickering flame effect and under bed glow the eko 1060 and 1070 range of low energy LED electric fires provides a real alternative to a gas fire that can be adapted to fit almost any fireplace requirement, thanks to it's two-part spacer frame.

The eko 1060/70 features a 2.0kW heat output, flame effect only setting – no heat, thermostatic control, timer control, full remote control or buttons on the front of the fire below the canopy. A helpful LED display is located in the top left hand corner of the window which displays, flame brightness, timer and thermostatic control.



Both the eko 1060/70 can feature either flame effects. Standard (left) or they can have the screen uprated to the reflections (right) screen to create a more realistic 3D flame effect. Please see comparison above.

### eko 1060

The entry level eko 1060 features an opaque screen which provides a warm flame picture with deep red tones.

### eko 1070

The eko 1070 Reflections model features an uprated screen. A premium piece of reflective glass increases the perceived depth of the fire by reflecting the coal fuelbed into the mirrored glass. This gives a much more realistic and vibrant flame picture and creates the illusion that the flames are originating from between the front and rear reflected coals.

## Specifications

Fire Type	LED Electric Fire
Control Type/Location	Manual - Button & Remote Control
Heat Direction	Frontwards
Heat Input (Max/Min) Gross	2.0kW / 1.0kW
Heat Output (Max/Min) Gross	2.0kW / 1.0kW
Running Costs Per Hour (Max/Min)*	31.68p / 15.84p
Outline Dimensions**	W480 x H595 x D114mm
Installation	Inset
Air Vent Required	N/A
Safety	Thermal Trip Switch
Options	N/A

\*Price based on 15.84p/kWh. Electric prices may vary. Please check with your supplier. For energy efficiency please refer to online product fiche on [www.ekofires.co.uk](http://www.ekofires.co.uk)

\*\*Please refer to Technical specification for more information.

See page 39 For more fret & frame options

**3year** guarantee





eko 1080 Edwardian



Model Shown:  
eko 1090 Reflections ref shown  
with the Victorian Timeless

# eko 1080/90

The eko 1080/90 combines traditional authentic techniques and innovative technology to create a stunning electric fire.

The beautiful 1080/90 features a 2.0kW heat output, flame effect only setting – no heat, thermostatic control, timer control, full remote control or buttons on the front of the fire below the canopy. A helpful LED display is located in the top left hand corner of the window which displays, flame brightness, timer and thermostatic control.

The decorative cast iron fascia is handcrafted and made from authentic iron foundry skills, which are individually polished by hand and available in a satin chrome or matt black finish..



Both the eko 1080/90 can feature either flame effects. Standard (left) or they can have the screen updated to the reflections (right) screen to create a more realistic 3D flame effect. Please see comparison above.

### eko 1080

The entry level eko 1080 features an opaque screen which provides a warm flame picture with deep red tones.

### eko 1090

The eko 1090 Reflections model features an updated screen. A premium piece of reflective glass increases the perceived depth of the fire by reflecting the coal fuelbed into the mirrored glass. This gives a much more realistic and vibrant flame picture and creates the illusion that the flames are originating from between the front and rear reflected coals.

## Specifications

Fire Type	LED Electric Fire
Control Type/Location	Manual - Button & Remote Control
Heat Directions	Frontwards
Heat Input (Max/Min) Gross	2.0kW / 1.0kW
Heat Output (Max/Min) Gross	2.0kW / 1.0kW
Running Costs Per Hour (Max/Min)*	31.68p / 15.84p
Outline Dimensions**	W480 x H595 x D114mm
Installation	Inset
Air Vent Required	N/A
Safety	Thermal Trip Switch
Options	N/A

\*Price based on 15.84p/kWh. Electric prices may vary. Please check with your supplier. For energy efficiency please refer to online product fiche on [www.ekofires.co.uk](http://www.ekofires.co.uk)

\*\*Please refer to Technical specification for more information.

**3year**  
guarantee

# 14

## Wall mounted electric fires

If you're searching for a stylish wall mounted electric fire without forfeiting warmth and efficiency, you're sure to find what you're looking for at eko fires. All of our models feature a flame effect only setting and simply plug in to the mains. They can be installed in a number of rooms as the unit does not require a chimney or flue. The innovative technology used in our products significantly improves the flame effect. Discover our stylish range of LED and LCD models today



### Technical specifications for installation

Electric fires require a fixed socket within 1.8 meters of the installed location. The socket must be easily accessible and NOT located directly above the appliance. It is recommended that any open flues be sealed off to prevent draughts from causing nuisance cut off. These appliances must NOT be installed into bathrooms or within the immediate vicinity of showers or swimming pools. Do not allow appliances to become covered as this may cause overheating.

### What safety features are on the appliance?

For your added safety all our electric products are fitted with a thermal trip switch that monitors the temperature inside the appliance, and senses any change if it becomes covered or displaced for any reason. Can the flame effect be used independent of heat? All electric appliances benefit by having the flame effect operational on its own for visual.

### Benefits of wall mounted electric fires

- No chimney or flue required
- Easy to use - simply take home and plug in
- Simply hang on the wall designs
- Can be installed on virtually any internal or external wall
- LED or LCD options available
- A wide range of portrait or landscape designs
- Timer control options (LED models only)
- Full thermostatic control (LED models only)



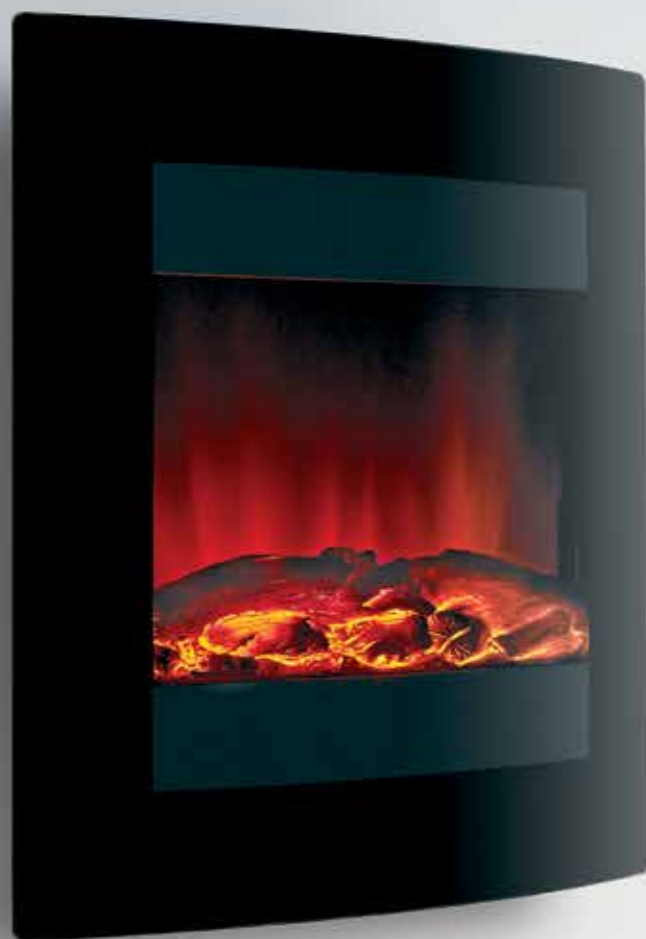

Model Shown:  
eko 1011 shown with  
curved black glass fascia

# eko 1011

Compact yet refined, this clever electric fire delivers style and performance to your living room where space is a premium.

The eko 1011 is a sleek and sophisticated wall mounted electric fire that simply hangs on the wall. It's ultra stylish curved black glass fascia exudes quality and fits with any modern interior. At the heart of this fire is a stunning log effect fuelbed with low energy LED flame effect that radiates a warm glow providing a beautiful focal point in your room.

The eko 1011 can be simply positioned on virtually any flat wall and plugs straight into a mains socket. A discrete bottom mounted fan heater with up to 1.5kW heat output gives a real punch of warmth to your room and better still can be operated from the remote control provided.

## Specifications

Fire Type	Portrait LED Electric Fire
Control Type/Location	Manual – Button (Right) & Remote Control
Heat Direction	Downwards
Heat Input (Max/Min) Gross	1.5kW / 0.75kW
Heat Output (Max/Min) Gross	1.5kW / 0.75kW
Running Costs Per Hour (Max/Min)*	23.76p / 11.88p
Outline Dimensions**	W520 x H620 x D148mm
Installation	Wall Mounted
Air Vent Required	N/A
Safety	Thermal Trip Switch
Options	N/A

\*Price based on 15.84p/kWh. Electric prices may vary. Please check with your supplier. For energy efficiency please refer to online product fiche on [www.ekofires.co.uk](http://www.ekofires.co.uk)

\*\*Please refer to Technical specification for more information.

**3**year  
guarantee



3 different backlight colours to choose from



Model Shown:  
eko 1011 Grand

Details:  
3 different fuel bed colours to choose from

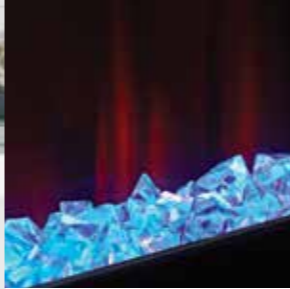
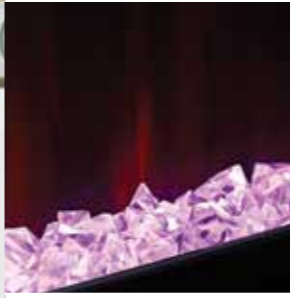

# eko 1011 Grand

A impressive focal point in the room and features a tall slimline profile along with a curved black glass fascia.

This fire can be operated manually (controls are located on the left hand side). To simplify operation a remote control is also provided. It has a variable heat output, thermostatic control and timer control. The eko 1011 Grand features a modern crystal fuelbed which illuminates in 3 colours along with the rear LED backlighting.

This versatile modern wall mounted electric fire simply hangs on the wall. A popular feature is that a TV can be positioned directly above the fire due to the fact that this electric wall hung fire has a fan heater at the bottom of the fire which directs the heat downwards.

## Specifications

Fire Type	Portrait LED Electric Fire
Control Type/Location	Manual – Switch (low left) & Remote Control
Heat Direction	Downwards
Heat Input (Max/Min) Gross	1.8kW / 0.9kW
Heat Output (Max/Min) Gross	1.8kW / 0.9kW
Running Costs Per Hour (Max/Min)*	28.51p / 14.26p
Outline Dimensions**	W432 x H965 x D152mm
Installation	Wall Mounted
Air Vent Required	N/A
Safety	Thermal Trip Switch
Options	N/A

\*Price based on 15.84p/kWh. Electric prices may vary. Please check with your supplier. For energy efficiency please refer to online product fiche on [www.ekofires.co.uk](http://www.ekofires.co.uk)

\*\*Please refer to Technical specification for more information.

**3year**  
guarantee



# eko 1100 LCD

Modern yet sophisticated wall mounted electric fire which features a high quality polished four piece black glass fascia

If you don't have a gas supply to your home but want to benefit from a focal point in your living room then the eko 1100 is a premium LCD electric fire that sets a new standard in digital electric fire design. At the heart of this innovative fire is an interactive multimedia processor which delivers a range of stunning real-life film sequences with optical clarity and breathtaking realism through the LCD display.

Details:  
9 seasonal video scenes

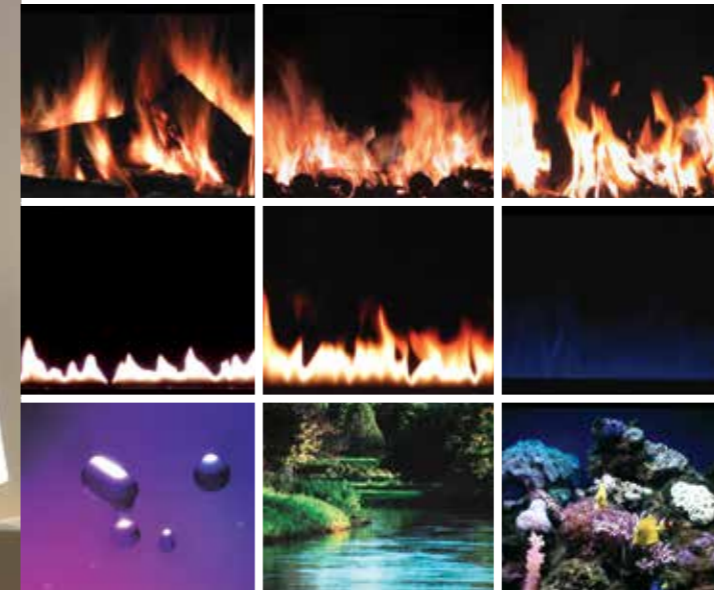

## Specifications

Fire Type	Landscape LCD Electric Fire
Control Type/Location	Manual - Switch & Remote control. Remote control operates the LCD effects & volume only.
Heat Direction	Upwards
Heat Input (Max/Min) Gross	2.0kW / 1.0kW
Heat Output (Max/Min) Gross	2.0kW / 1.0kW
Running Costs Per Hour (Max/Min)*	31.68p / 15.84p
Outline Dimensions**	W760 x H465 x D100mm
Installation	Wall Mounted
Air Vent Required	N/A
Safety	Thermal Trip Switch
Options	N/A

\*Price based on 15.84p/kWh. Electric prices may vary. Please check with your supplier. For energy efficiency please refer to online product fiche on [www.ekofires.co.uk](http://www.ekofires.co.uk)

\*\*Please refer to Technical specification for more information.

**3**year  
guarantee





Model Shown:

(left) eko 1110 black (below) eko 1110 mirrored



# eko 1110

This versatile modern wall mounted electric fire simply hangs on the wall and a popular feature is that a TV can be positioned directly above the fire. This is due to the fact that the eko 1110 has a fan heater at the bottom of the fire which directs the heat downwards.

The eko 1110 features: 1.8kW variable heat output, flame effect only - no heat, 5 flame picture settings, thermostatic control which automatically turns the heater on and off to your desired temperature, timer, LED flame picture technology, full remote control or buttons on the underside of the fire and has a helpful LED display located in the top right hand corner of the window which displays the heat setting, flame cycle and sleep timer.

## Specifications

Fire Type	Landscape LED Electric Fire
Control Type/Location	Low Level - Right - Underside Manual Buttons & Remote Control
Heat Direction	Downwards
Heat Input (Max) Gross	1.8kW / 0.9kW
Heat Output (Max) Gross	1.8kW / 0.9kW
Running Costs Per Hour (Max/Min)*	28.51p / 14.26p
Outline Dimensions**	W810 x H505 x D160mm
Installation	Wall mounted
Air Vent Required	N/A
Safety	Thermal Trip Switch
Options	Black Glass or Mirrored

\*Price based on 15.84p/kWh. Electric prices may vary. Please check with your supplier. For energy efficiency please refer to online product fiche on [www.ekofires.co.uk](http://www.ekofires.co.uk)

\*\*Please refer to Technical specification for more information.

**3**year  
guarantee





3 different  
backlight colours  
to choose from



Model Shown:  
eko 1120 wall mounted

Details:  
Comes with stand for the  
option of not wall mounting



### Specifications

Fire Type	Landscape LED Electric Fire
Control Type/Location	Low Level - Right - Underside Manual Buttons & Remote Control
Heat Direction	Downwards
Heat Input (Max) Gross	1.5kW / 0.75kW
Heat Output (Max) Gross	1.5kW / 0.75kW
Running Costs Per Hour (Max/Min)*	23.76p / 11.88p
Outline Dimensions**	W915 x H440 x D125mm With Stand H550 x D249mm
Installation	Wall Mounted / Freestanding
Air Vent Required	N/A
Safety	Thermal Trip Switch
Options	N/A

\*Price based on 15.84p/kWh. Electric prices may vary. Please check with your supplier. For energy efficiency please refer to online product fiche on [www.ekofires.co.uk](http://www.ekofires.co.uk)

\*\*Please refer to Technical specification for more information.

# eko 1120

This versatile modern wall mounted electric fire simply hangs on the wall and a popular feature is that a TV can be positioned directly above the fire. This is due to the fact that the eko 1120 has a fan heater at the bottom of the fire which directs the heat downwards.

The eko 1120 features: 1.5kW variable heat output, flame effect only - no heat, 4 flame picture settings, thermostatic control, timer, LED flame picture technology, full remote control or buttons on the right hand side of the fire and has a helpful LED display located in the top right hand corner of the window which displays the heat setting, flame cycle and sleep timer.

Please note: the LED display is only shown when changing a function. An additional benefit is that you can also position a TV above the fire as the fan heater is located at the base of the fire for front facing heat (stand fitted) or downwards heat (stand removed).

The eko 1120 comes with a choice of three different fuel beds log effect, plastic crystals and real pebbles.

**3year**  
guarantee



3 different backlight colours to choose from



Model Shown:  
eko 1190

Details:  
3 different fuel beds, log effect, plastic crystals and real pebbles. Also available in Limestone



# eko 1190

The enhanced proportions of this stylish fire create a beautiful panoramic view of the flames, while the natural stone fascia exude style.

The eko 1190 wall mounted electric fire has been designed to combine the natural stone front with the latest LED electric fire technology. The high-end aesthetic equally suits a contemporary, modern, traditional or classic interior decor. The innovative polished black granite or limestone stone frame is manufactured using a clever aluminium honeycomb subframe. This process not only helps to increase the manufacturing precision but also helps to reduce the weight so that it can be wall mounted.

The eko 1190 LED features: 1.5kW variable heat output, flame effect only - no heat, 4 flame picture settings, thermostatic control, timer, LED flame picture technology, full remote control or buttons on the right hand side of the fire and has a helpful LED display located in the top right hand corner of the window which displays the heat setting, flame cycle and sleep timer.

Please note: the LED display is only shown when changing a function.

## Specifications

Fire Type	Landscape LED electric fire
Control Type/Location	Low Level - Right - Under-side manual buttons & remote control
Heat Direction	Downwards
Heat Input (Max/Min) Gross	1.5kW / 0.75kW
Heat Output (Max/Min) Gross	1.5kW / 0.75kW
Running Costs Per Hour (Max/Min)*	23.64p / 11.88p
Outline Dimensions**	W1100 x H385 x D140mm
Installation	Wall Mounted
Air Vent Required	N/A
Safety	Thermal Trip Switch
Options	Black Granite / Limestone

\*Price based on 15.84p/kWh. Electric prices may vary. Please check with your supplier. For energy efficiency please refer to online product fiche on [www.ekofires.co.uk](http://www.ekofires.co.uk)

\*\*Please refer to Technical specification for more information.

**3year**  
guarantee



# 28

## Electric stoves & suites

When it comes to stoves, the lack of a gas supply should not restrict your choices. With an electric stove, you can enjoy the warmth it gives to a room. These stand-alone electrical stoves make a glorious focal point for your living space, and they function using innovative LED.

Our freestanding electric fire suite come complete as a one box solution, without the fuss of buying all the separate fireplace items.

Our stoves and suite look stylish and are easy to install - simply place against any flat wall, plug in and enjoy.



### Technical specifications for installation

Electric fires require a fixed socket within 1.8 meters of the installed location. The socket must be easily accessible and NOT located directly above the appliance. It is recommended that any open flues be sealed off to prevent down draughts from causing nuisance cut off. These appliances must NOT be installed into bathrooms or within the immediate vicinity of showers or swimming pools. Do not allow appliances to become covered as this may cause overheating.

### What safety features are on the appliance?

For your added safety all our electric products are fitted with a thermal trip switch that monitors the temperature inside the appliance, and senses any change if it becomes covered or displaced for any reason. Can the flame effect be used independent of heat? All electric appliances benefit by having the flame effect operational on its own for visual.

### Benefits of electric stoves & suites

- No chimney or flue required
- Easy to use - simply take home and plug in
- Can be installed on virtually any internal or external wall
- A choice of modern or traditional designs to suit your interior
- Remote control
- Timer control options (Model dependent)
- Full thermostatic control (Model dependent)
- Log effect fuel bed



Model Shown:  
eko 1150

# eko 1150

The eko 1150 is a modern electric stove which features LED technology designed to significantly improve the flame picture and running performance.

LED technology not only provides a deeper, richer flame picture with enhanced flame movement but is also a fraction of the cost to run when compared to a conventional incandescent bulb. It will last a lot longer too. The eko 1150 is freestanding stove allowing you to stand in almost any location or position and the heater is omitted out of the bottom canopy. The mains power lead is approx. 1.6m long.

The controls are positioned on the right hand side of the stove to allow for easy access but the eko 1150 also features a remote control. The eko 1150 can be selected to operate without the heat and just have a flame effect only setting so you can enjoy the look and feel of a flickering flame (without heat) for an all year round focal point.



## Specifications

Fire Type	LED Electric Stove
Control Type/Location	High Level - Right - Side Manual buttons & Remote Control
Heat Direction	Frontwards
Heat Input (Max/Min) Gross	1.5kW / 0.75kW
Heat Output (Max/Min) Gross	1.5kW / 0.75kW
Running Costs Per Hour (Max/Min)*	23.76p / 11.88p
Outline Dimensions**	W477 x H710 x D352mm
Installation	Freestanding
Air Vent Required	N/A
Safety	Thermal Trip Switch
Options	N/A

\*Price based on 15.84p/kWh. Electric prices may vary. Please check with your supplier. For energy efficiency please refer to online product fiche on [www.ekofires.co.uk](http://www.ekofires.co.uk)

\*\*Please refer to Technical specification for more information.

**3**year  
guarantee





Model Shown:  
eko 1250 white with open glass window  
(below) eko 1250 black arched door

# eko 1250

The eko 1250 LED electric stove looks and feels like a real wood burner but doesn't have any of the drawbacks of a solid fuel stove. No chimney or flue is required, nor storage for logs and there's certainly no cleaning of ashes after use. The simplicity of electric at your fingertips and instant heat provides a system that is far superior to operate and cleaner to maintain.

The eko 1250 design features two door styles, a beautiful arch door with lattice detail or a large uninterrupted glass window that allows the fire to be enjoyed in all its beauty. It is made from solid cast iron and available in black or white powdercoat finish. And, finally to complement the overall aesthetic, a matching door handle and slide control handle is supplied finished in brushed stainless steel.

The electric stove can be operated either by the control panel or by remote control. The control panel is located on the top of the stove underneath a discreet panel on top of the stove. The eko 1250 benefits from having a 1.8kW variable fan heater which allows you to choose from 10 different power settings 18°C - 27°C, or you can use the flame effect only - no heat, 4 flame picture settings, timer, LED flame picture technology.

In addition to these benefits an electric stove will be significantly cheaper to install as you will simply only need to plug in to feel the heat.



## Specifications

Fire Type	LED Electric Stove
Control Type/Location	Manual - Button Control
Heat Direction	Frontwards
Heat Input (Max/Min) Gross	1.8kW / 1.5kW
Heat Output (Max/Min) Gross	1.8kW / 1.5kW
Running Costs Per Hour (Max/Min)*	28.51p / 23.76p
Outline Dimensions**	W615 x H630 x D385mm
Installation	Freestanding
Air Vent Required	N/A
Safety	Thermal Trip Switch
Options	N/A

\*Price based on 15.84p/kWh. Electric prices may vary. Please check with your supplier. For energy efficiency please refer to online product fiche on [www.ekofires.co.uk](http://www.ekofires.co.uk)

\*\*Please refer to Technical specification for more information.

**3 year**  
guarantee



Model Shown:  
eko 1350 black  
(below) eko 1350 white

# eko 1350

Wood burning-effect stoves are the latest must-have in home decoration. Powerful, efficient and versatile. With the next generation of electric stoves you too can create a realistic focal point that works equally in urban city living as it is in rural country abodes.

The eko 1350 LED electric stove looks and feels like a real wood burner but doesn't have any of the drawbacks of a solid fuel stove. No chimney or flue is required, nor storage for logs and there's certainly no cleaning of ashes after use. The simplicity of electric at your fingertips and instant heat provides a system that is far superior to operate and cleaner to maintain. In addition to these benefits an electric stove will be significantly cheaper to install as you will simply only need to plug in to feel the heat.

The eko 1350 features a fabricated metal body and is available in matt black or white finish. At the heart of the stove is a large glass window that allows the fire to be enjoyed in all its beauty. And, finally to add detail and complement the overall aesthetic, a matching door handle and slide control handle is finished in brushed stainless steel.

The electric stove can be operated either by the control panel or by remote control. The control panel is located on the top of the stove underneath a discreet panel on top of the stove. The eko 1350 benefits from having a 1.8kW variable fan heater which allows you to choose from 10 different power settings 18°C - 27°C, or you can use the flame effect only - no heat, 4 flame picture settings, timer, LED flame picture technology.



## Specifications

Fire Type	LED Electric Stove
Control Type/Location	Manual - Button Control
Heat Direction	Frontwards
Heat Input (Max/Min) Gross	1.8kW / 1.5kW
Heat Output (Max/Min) Gross	1.8kW / 1.5kW
Running Costs Per Hour (Max/Min)*	28.51p / 23.76p
Outline Dimensions**	W615 x H637 x D320mm
Installation	Freestanding
Air Vent Required	N/A
Safety	Thermal Trip Switch
Options	N/A

\*Price based on 15.84p/kWh. Electric prices may vary. Please check with your supplier. For energy efficiency please refer to online product fiche on [www.ekofires.co.uk](http://www.ekofires.co.uk)

\*\*Please refer to Technical specification for more information.

**3year**  
guarantee





Model Shown:  
eko 1200

# eko 1200

The eko 1200 complete electric fireplace suite is a fully assembled electric fire suite. It features an all white surround, back panel and hearth. The fireplace suite has a 1.5kW heater with a realistic log effect fuel bed.

The realistic flame effect can be used independently of the heater and the fire also features an LED display, remote control, timer and thermostatic control options.

## Specifications

Fire Type	LED Electric Suite
Control Type/Location	Manual - Switch & Remote Control
Heat Direction	Frontwards
Heat Input (Max/Min) Gross	1.5kW / 0.75kW
Heat Output (Max/Min) Gross	1.5kW / 0.75kW
Running Costs Per Hour (Max/Min)*	23.76p / 11.88p
Outline Dimensions**	W1140 x H886 x D240mm
Installation	Freestanding
Air Vent Required	N/A
Safety	Thermal Trip Switch
Options	N/A

\*Price based on 15.84p/kWh. Electric prices may vary. Please check with your supplier. For energy efficiency please refer to online product fiche on [www.ekofires.co.uk](http://www.ekofires.co.uk)

\*\*Please refer to Technical specification for more information.

**3year**  
guarantee

# Tailoring specification



















## Available options

■ Indicates non-applicable

	Type	Remote control	Coal*	Log*	Pebble*	Crystals*	9 scenes
<b>Inset electric fires</b>							
eko 1030	LCD	✓	■	■	■	■	✓
eko 1040	LCD	✓	■	■	■	■	✓
eko 1060	LED	✓	✓	■	■	■	■
eko 1070	LED	✓	✓	■	■	■	■
eko 1080	LED	✓	✓	■	■	■	■
eko 1090	LED	✓	✓	■	■	■	■
<b>Wall mounted electric fires</b>							
eko 1011	LED	✓	■	✓	■	■	■
eko 1011 Grand	LED	✓	■	■	■	✓	■
eko 1100 LCD	LCD	✓	■	■	■	■	✓
eko 1110	LED	✓	■	✓	■	■	■
eko 1120	LED	✓	■	✓	✓	✓	■
eko 1190	LED	✓	■	✓	✓	✓	■
<b>Stoves electric &amp; complete electric suites</b>							
eko 1150	LED	✓	■	✓	■	■	■
eko 1250	LED	✓	■	✓	■	■	■
eko 1350	LED	✓	■	✓	■	■	■
eko 1200	LED	✓	■	✓	■	■	■

\*Please note that Fuel beds are not the real materials stated and are created to replicate the effects of the mentioned.

## Frets and frames available to choose

					
Elysee - FRT110 Brass	Elysee - FRT120 Brass & Black	Elysee - FRT130 Chrome & Black	Elysee - FRT140 Black	Elysee - FRT160 Brushed Chrome	Blenhiem - FRT310 Brass
					
Blenhiem - FRT320 Brass & Black	Blenhiem - FRT330 Chrome & Black	Blenhiem - FRT340 Black	Blenhiem - FRT360 Brushed Chrome	Elegance - FRT210 Brass	Elegance - FRT220 Brass & Black
					
Elegance - FRT230 Chrome & Black	Elegance - FRT240 Black	Elegance - FRT260 Brushed Chrome	Mono - FRT410 Brass	Mono - FRT420 Chrome	Mono - FRT460 Brushed Chrome

					
Contemporary Stainless steel	Contemporary Brass	Contemporary Black	Classic Plain Black	Classic Plain Brass	Classic Plain Chrome



# Technical specification

## Product dimensions

■ Indicates non-applicable

	Type	Product dimensions													Opening dimensions				
		A	B	B1	C	C1	C2	D1	D2	E	F	J	K	L	X MIN	X MAX	Y MIN	Y MAX	Z MAX
<b>Inset electric fires</b>																			
eko 1030 / 40	Inset	480	595	■	95	20	75	390	480	540	■	■	■	■	400	450	560	580	0**
eko 1060 / 70	Inset	480	595	■	114	57	57	390	480	555	■	■	■	■	400	450	560	580	0**
eko 1080 / 90	Inset	480	595	■	114	57	57	390	480	555	■	■	■	■	400	450	560	580	0**
<b>Wall mounted electric fires</b>																			
eko 1011	Wall mounted	520	620	■	150	■	■	380	■	565	■	■	■	■	■	■	■	■	■
eko 1011 Grand	Wall mounted	432	965	■	152	■	■	320	■	825	■	■	■	■	■	■	■	■	■
eko 1100 LCD	Wall mounted	760	465	■	100	■	■	500	■	400	■	■	■	■	■	■	■	■	■
eko 1110	Wall mounted	810	505	■	160	■	■	530	■	475	■	■	■	■	■	■	■	■	■
eko 1120	Wall mounted	915	440	550	125	249	■	820	■	360	■	■	■	■	■	■	■	■	■
eko 1190	Wall mounted	1100	385	■	140	■	■	820	■	360	■	■	■	■	■	■	■	■	■
<b>Stoves electric &amp; complete electric suites</b>																			
eko 1150	stove	477	710	■	352	■	■	■	■	■	■	■	■	■	■	■	■	■	■
eko 1250	stove	615	630	■	385	■	■	■	■	■	■	■	■	■	■	■	■	■	■
eko 1350	stove	615	637	■	320	■	■	■	■	■	■	■	■	■	■	■	■	■	■
eko 1200	suite	1140	886	■	240	■	■	■	■	■	1059	1140	50	330	■	■	■	■	■

## Product schematics

### Inset electric fires

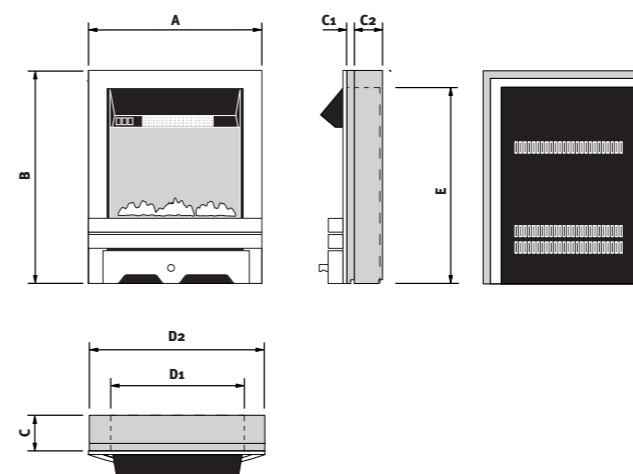

\*\*Electric inset – Includes two spacer frames. To allow the electric fire to be installed on a flat wall, semi recessed and fully recessed.

### Wall mounted electric fires

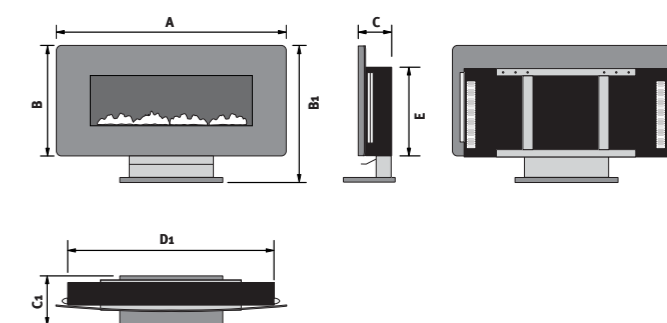

The eko 1120 comes with a removable stand.

### Stoves electric

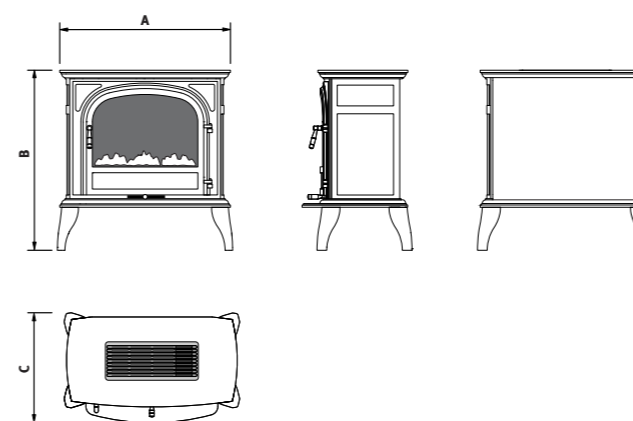

### Complete electric suite

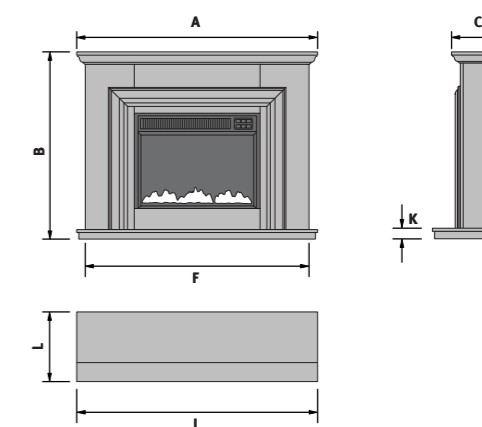

# Tailoring specification - surrounds

## Available options



# Technical specification - surrounds

## Surround product dimensions

	Type	Product dimensions						Rebate	
		A	B	C	D	E	F		
<b>Wooden fireplace surrounds</b>									
eko 7010	Surround	1195	1030	145	800	880	1092	25	
eko 7020	Surround	1100	1022	185	740	803	1030	25	75
eko 7030	Surround	1220	1172	210	720	874	1112	25	
eko 7040	Surround	1340	1140	205	898	888	1286	25	75
eko 7050	Surround	1212	1041	197	762	786	1110	25	75
eko 7060	Surround	1375	1125	180	910	910	1190	25	75
eko 7070	Surround	1300	1172	185	890	910	1174	25	75
eko 7080	Surround	1170	1030	150	770	830	1170	25	75
eko 7090	Surround	1300	1120	185	860	905	1200	25	75

## Surround schematics

- A Overall width
- B Overall height
- C Overall depth
- D Internal width
- E Internal height
- F Leg width

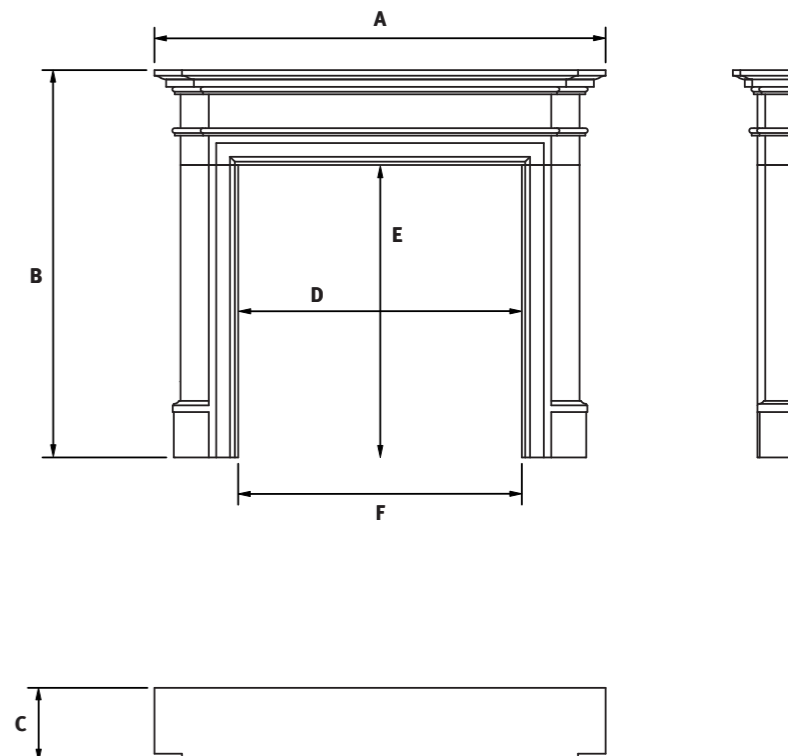



# Terms & conditions

## 3 Year Guarantee - Terms & Conditions

The 3 year guarantee is only applicable to purchases made through an authorised ekofires stockist. Please see our ekofires website, [www.ekofires.co.uk](http://www.ekofires.co.uk) for a list of authorised stockists. Any purchase(s) made through an unauthorised stockist(s) will be eligible for a statutory 1 year guarantee.

For all gas fires purchased the 3 year guarantee commences from the date of purchase, provided that the following 4 terms and conditions are adhered to:

1. For any claim to be made within the 3 years from date of purchase you will be required to provide and supply us with your proof of purchase.
2. Your gas fire must have been commissioned by a Gas Safe registered engineer, evidence of which you must provide together with the a registration number.
3. Your appliance must have been serviced annually by a Gas Safe registered engineer, evidence of which must be provided, such as the receipt.
4. Purchase(s) must be made through an authorised stockist.

Please note all consumable items such as any ceramics including; coals, pebbles, the matrix, front strips, side cheeks, rear panels and tapered rear panels are not covered by the 3 year guarantee.

For all electric fires purchased the 3 year guarantee commences

## Focused

All fires are manufactured under strict guidelines of BS EN ISO9001, an internationally recognised standard for Quality management. ISO9001 governs many aspects of the company, from the goods inwards procedures of checking the quality of components coming in to our factories, through production control, to customer service available for appliances manufactured by us. In 2000, we become the first company in our sector to be accredited with BS EN ISO14001. This standard marks our commitment to the environment and covers everything from recycled materials and biodegradable products, to energy efficiency within the work place.

## Patent information

All flueless gas fires are protected under patent GB2275331B. Our range of high efficiency flued gas fires are protected under patent GB2356698B.

from the date of purchase, providing that you can supply the proof of purchase. This does not cover consumable items such as pebbles, coals or light bulbs. Purchase(s) must be made through an authorised stockist.

## Making a claim

Making a claim is easy. If you wish to make a claim under our 3 year guarantee and all the terms and conditions for your product have been met then please submit the following information for the attention of the 3G Service Department to the address below. Alternatively, you can email or fax.

ekofires, 3G Service Department, Reid Street, Christchurch, Dorset, BH23 2BT.

Email: [3g@ekofires.co.uk](mailto:3g@ekofires.co.uk), Fax. 01202 588 639.

Details required:

1. Name, full address including post code and contact telephone number.
2. Receipt of purchase or credit card statement.
3. Original installers Gas Safe registration number (gas fires only).
4. Annual service receipt for every 12 months (gas fires only).

Please note that this does not affect your statutory rights.

## Important notice

This brochure was correct at publication, however as our policy is one of continual development and improvement specifications may be subject to change. Any such changes will not adversely affect the performance or safety of the appliance. All flueless appliances are intended as a secondary source of heat and should only be used with some form of background heating present. All appliances must be installed in a correctly ventilated space in accordance with the manufacturer's installation instructions and the rules in force. This brochure is for guidance only and is not intended to replace the installation manual, which provides more detailed information. All of our fires carry CE Approval which is compulsory for all gas and electric fires sold within the EU. Specifications are valid for Great Britain and Republic of Ireland only.

November 2017 (1). ©ekofires.